

SCALE
1/700

USS Missouri BB-63



14223

ACADEMY

HOBBY MODEL KITS

Warning in Assembly of Model Kits

조립전의 주의사항

Take care not to injure yourself while using the modeling tools to cut or trim parts.
공구를 이용하여 부품을 다듬고 자를 경우, 손을 다치지 않도록 주의를 기울여 주십시오.



CAUTION!

-주의-

<READ THIS BEFORE YOU BEGIN>

<ALLGEMEINE HINWEISE>

<LISEZ CE QUI SUIT AVANT DE COMMENCER LE MONTAGE>

<組み立てる前に>

<조립하기 전에 먼저 읽어 주십시오>

<READ THIS BEFORE YOU BEGIN>

- Study the instructions before assembling. - Check the fit of each piece before cementing into place.
- Do not use too much cement to join parts. - Never use cement or paint near open flame.
- Open a window or make area well ventilated when cement or paint is in use.
- Tear up and throw away the empty plastic bags to avoid danger of suffocation for little children.

<ALLGEMEINE HINWEISE>

- Die Anordnung der Bauteile ist aus den Zeichnungen der Anleitung ersichtlich.
- Die Teile vor dem Verkleben ungeleimt zusammenhalten, um ihnen paßsitz zu prüfen.
- Klebstoff nicht zu dick auftragen. - Klebstoff und Farben niemals in der Nähe einer Flamme verwenden.
- Während der Bemalung mit Spritzpistole oder Pinsel für frische Luftzufuhr, z.B. Öffnen des Fensters, sorgen.
- Bausatz von kleinen Kindern fernhalten. Verhüten Sie, daß Kinder irgendwelche Bauteile in den Mund nehmen oder Plastiktüten über den Kopf ziehen.

<LISEZ CE QUI SUIT AVANT DE COMMENCER LE MONTAGE>

- Etudier les schémas d'assemblage. - Contrôler que chaque pièce soit bien conforme avant de la coller à sa place.
- N'utilisez pas trop de colle pour réunir les pièces. - Ne faites jamais manipuler la colle ou peinture à proximité d'une flamme.
- Aérer soigneusement la pièce où vous peignez (ouvrir la fenêtre).
- Après avoir sorti les pièces du sac en plastique, déchirer le sac afin d'éviter que les enfants ne le mettent sur la tête et ne s'étouffent.

<組み立てる前に>

- 組み立てる前に説明書をお読み下さい。 -部品をランナーから切りはなす時は模型用ニッパーとカッターを使用します。
- 接着剤を少しなめに塗ることがきれいに仕上げるコツです。 -接着する前に部品を合わせて確かめます。
- 接着剤や塗料を使用する時はときどき窓を開けて換気をお願いします。
- 組み立て後の部品やビニール袋は小さな子供の手の届かない安全な所に保管して下さい。

■조립하기 전에

- 부품을 조립하기 전에 설명서를 잘 읽어본 후 조립한다.
- 접착하기 전에 부품을 맞추어 확인한 후 조립한다.
- 부품을 자를 때에는 칼이나 니퍼로 깨끗이 잘라준다.
- 접착제를 사용할 곳과 사용하지 않는 곳에 주의하고 너무 많이 바르지 않도록 한다.
- 에나멜 페인트나 접착제를 사용할 때는 창문을 열어 환기를 시키고 화기를 멀리한다.
- 사용 후 남은 부품은 어린 아이들의 손에 닿지 않도록 잘 처리한다.

CEMENT

접착제 사용



접착제 금지



수만큼 조립

DECAL

전사지

BALLAST

무게추

FILL

채움

CUT

잘라냄



선택



반대측 조립



뚫어줌



주의



버전

MAIN COLOR

HAZE GRAY 5-H 헤이즈 그레이 | SEA BLUE 5-S 씨 블루 | DECK BLUE 20-B 데크 블루 | HULL RED 헬 레드

PAINT INDEX	Humbrol	GSI Creos		Lifecolor	TESTORS / MODELMASTER		Revell		Vallejo			
		ENAMEL	ACRYL		AQUEOUS HOBBYCOLOR	MR. COLOR	ENAMEL	ACRYL	ENAMEL	ACRYL		MODEL COLOR
1 HAZE GRAY 5-H	126	126	H306	306	UA625	1725	4238	32374	36374	905		헤이즈 그레이
2 OCEAN GRAY 5-O	156	156	H335	13	UA621			32179	36179	992		오션 그레이
3 SEA BLUE 5-S	96	96	H55	71	UA623					965+903		씨 블루
4 DECK BLUE 20-B			H54+H55	365	UA624					867		데크 블루
5 NAVY BLUE FS15042	181		H54	14	UA047	1717	4686	32350	36350	898	87	네이버 블루
6 INTERMEDIATE BLUE FS35164	144		H56	366	UA045	1720	4744			903		인터미디어이트 블루
7 HULL RED	177		H17	29	LC37					985	39	헬 레드
8 FLAT BLACK	33	33	H12	33	LC02	1749	4768	32108	36108	950	57	무광 검은색
9 FLAT WHITE	34	34	H11	62	LC01	1768	4769	32105	36105	951	1	무광 흰색
10 STEEL	53	53	H18	28	LC76	1795	4681	32191	36191	863	72	스틸
11 SILVER	11	11	H8	8	LC74	2914	4678	32190	36190	997	63	은색
12 GOLD	16	16	H9	9	LC75	1744	4671	32194	36194	996	66	금색

1



접착제 사용

Hull part 3
선체 부품 3

Hull part 1
선체 부품 1

Hull part 2
선체 부품 2

※ Start assemble with number ①
①번부터 조립 합니다.

2



접착제 사용

※ Start assemble with number 1

1번부터 조립 합니다.

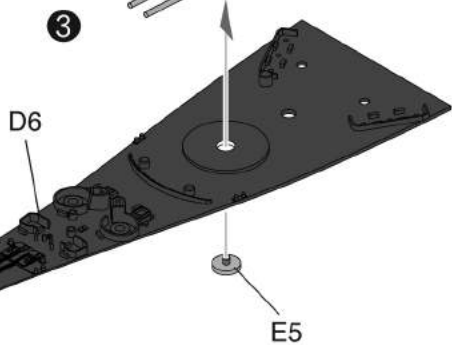
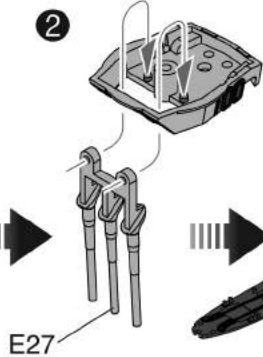
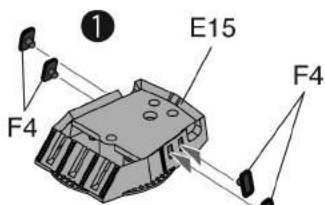

4

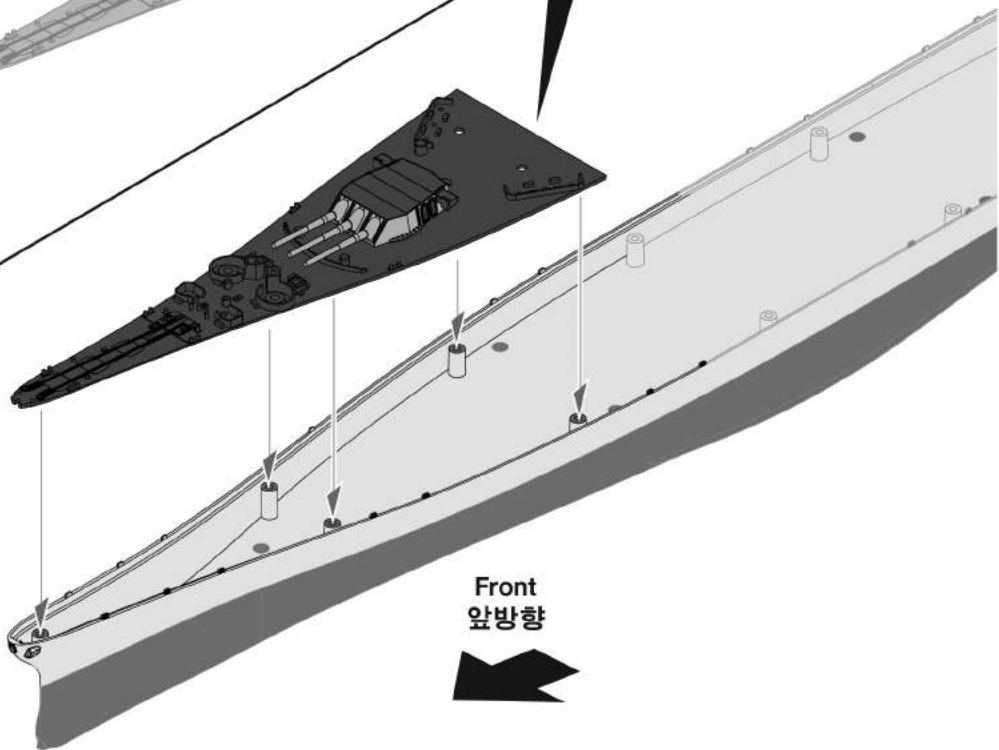
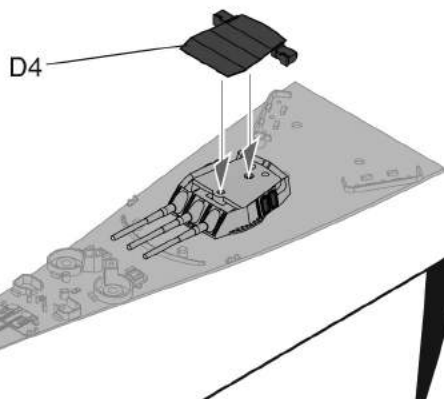

3



접착제 사용

※ Start assemble with number ①
①번부터 조립 합니다.

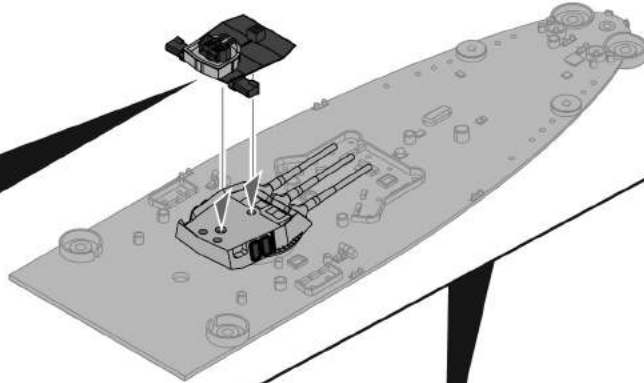
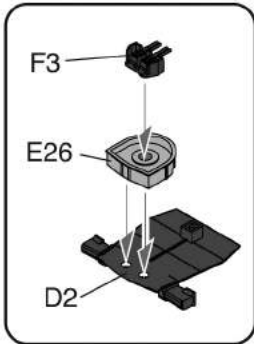
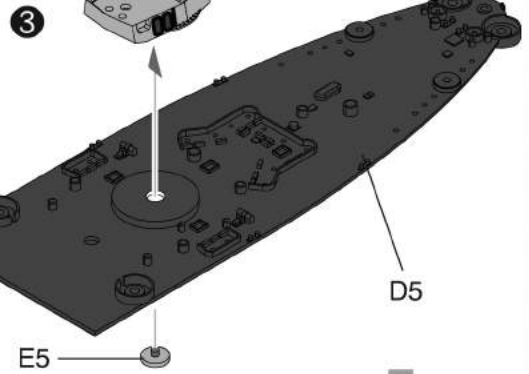
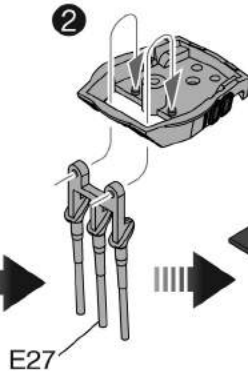
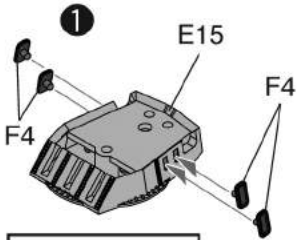

④

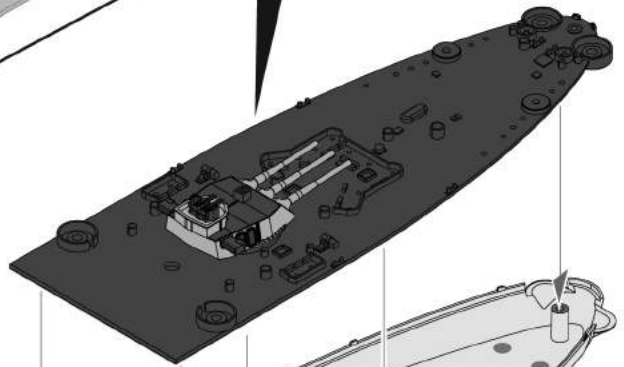

Front
앞방향



4

CEMENT

접착제 사용

Rear view

후면



※ Note the direction!
방향에 주의 하세요!

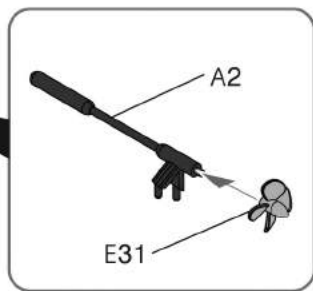
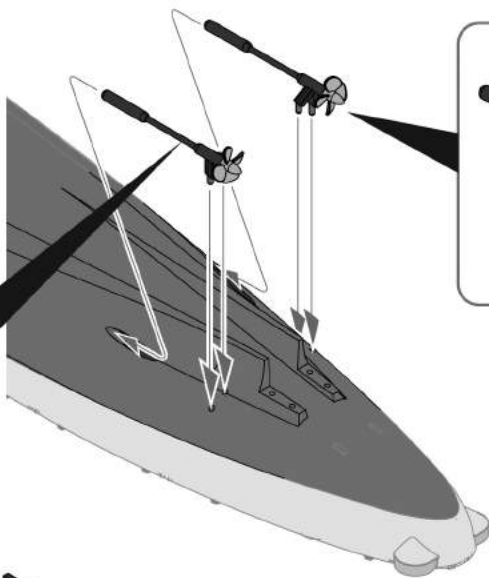
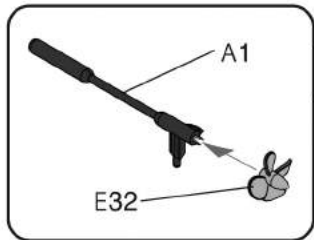

Rear view

후면



※ Note the direction!
방향에 주의 하세요!

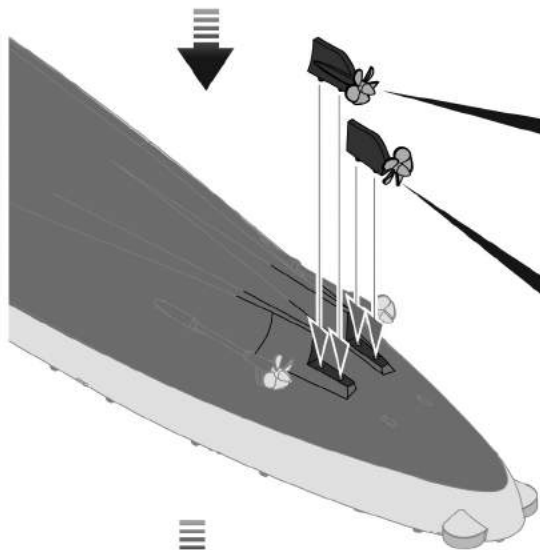
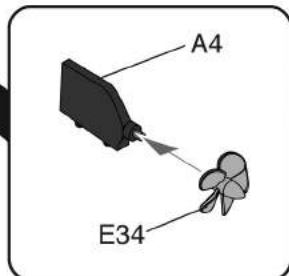
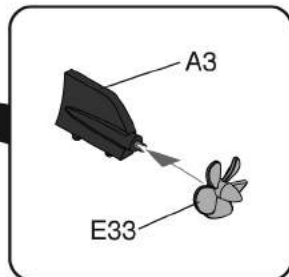

Front
앞방향

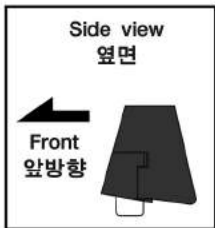
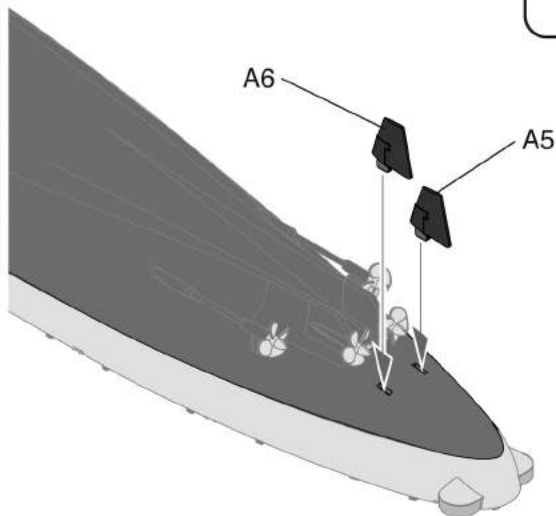

※ Note the direction!
방향에 주의 하세요!

5



접착제 사용

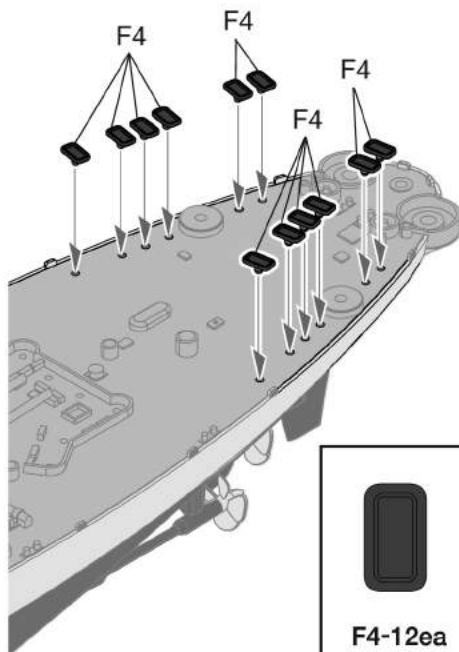
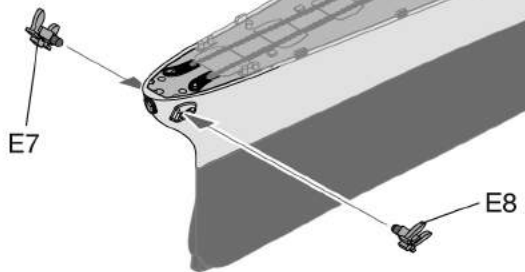
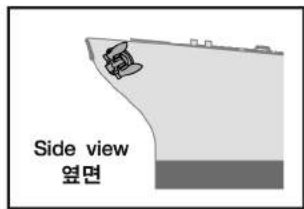

6



접착제 사용

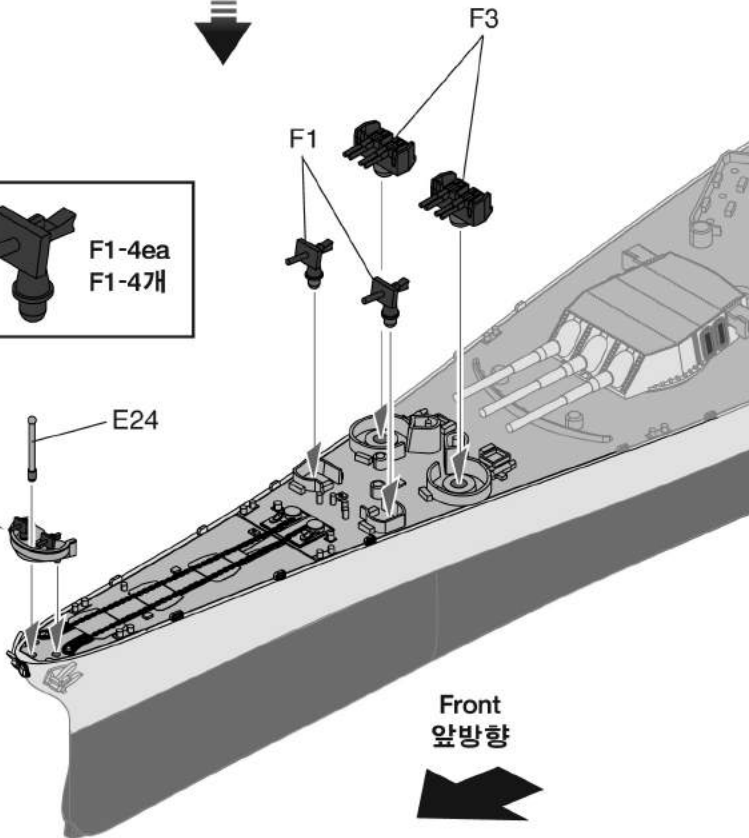
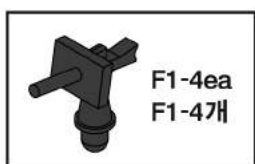
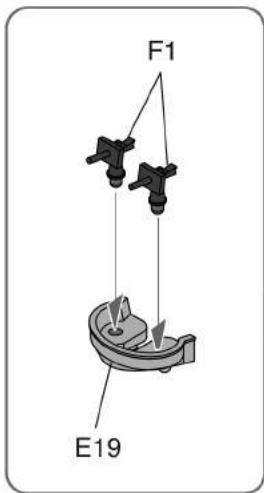

7

CEMENT

점착제 사용

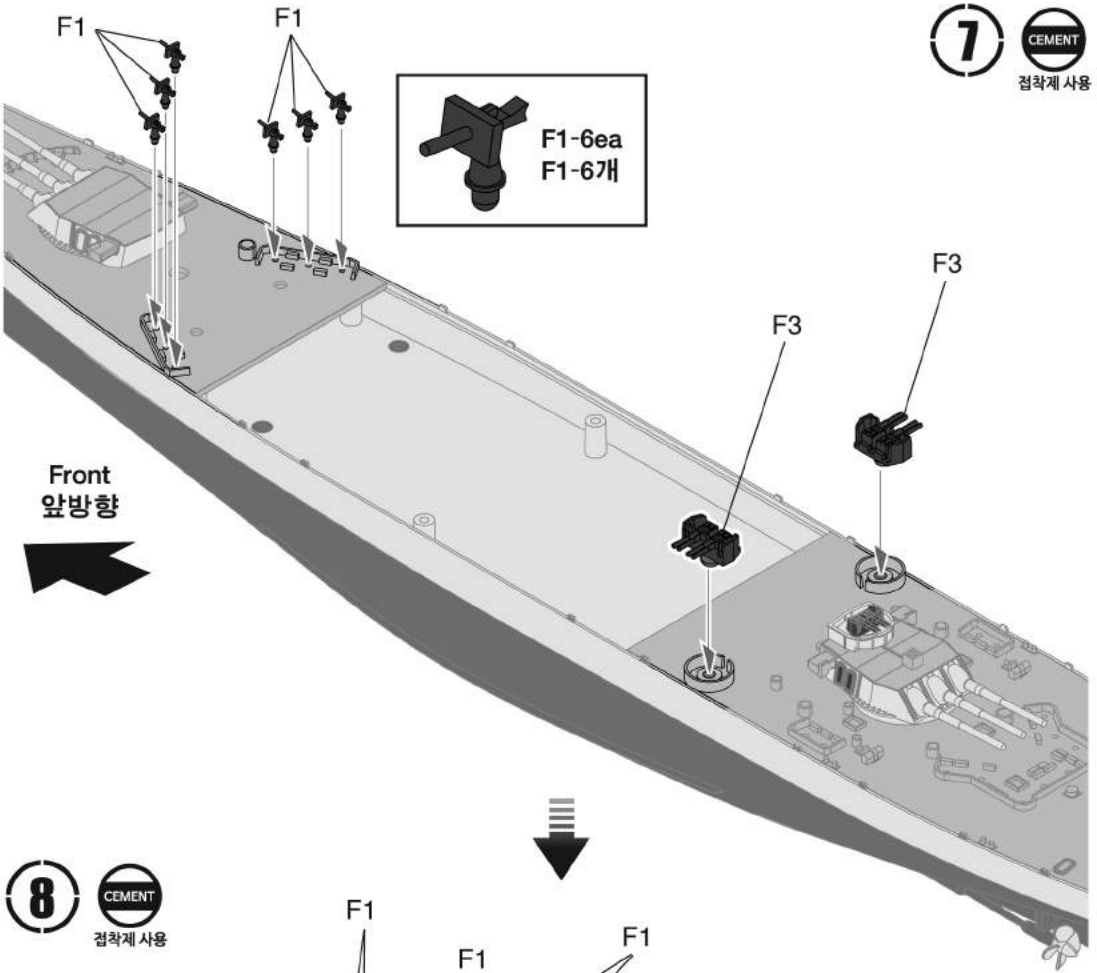

8

CEMENT

점착제 사용

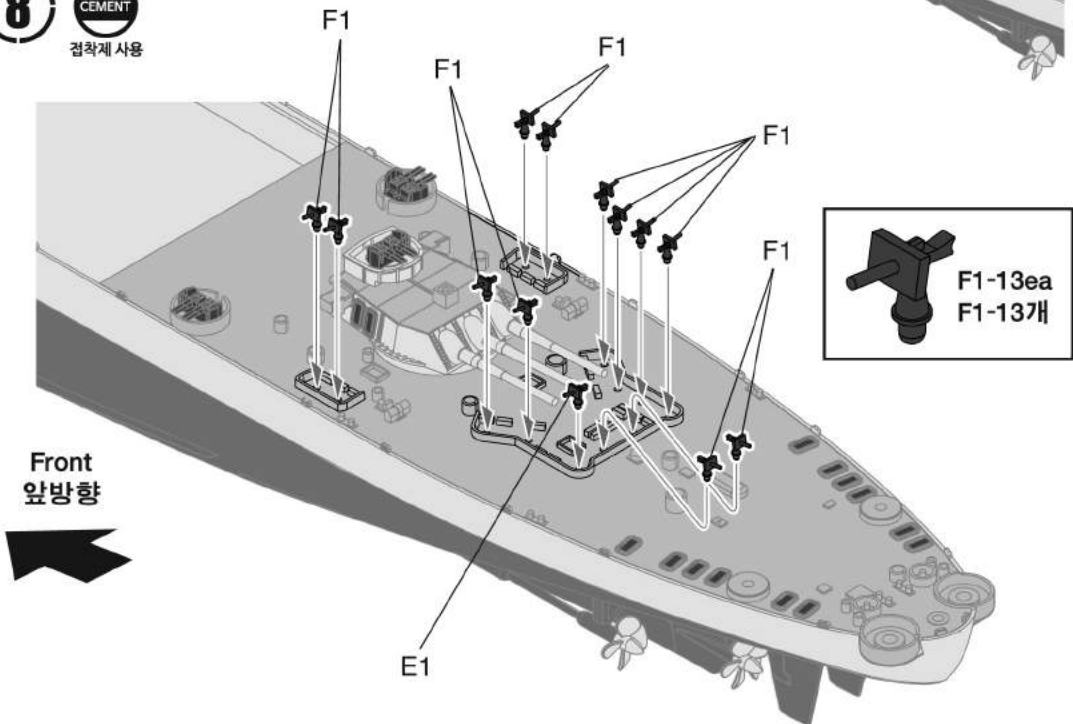

9



점착제 사용

Front
앞방향

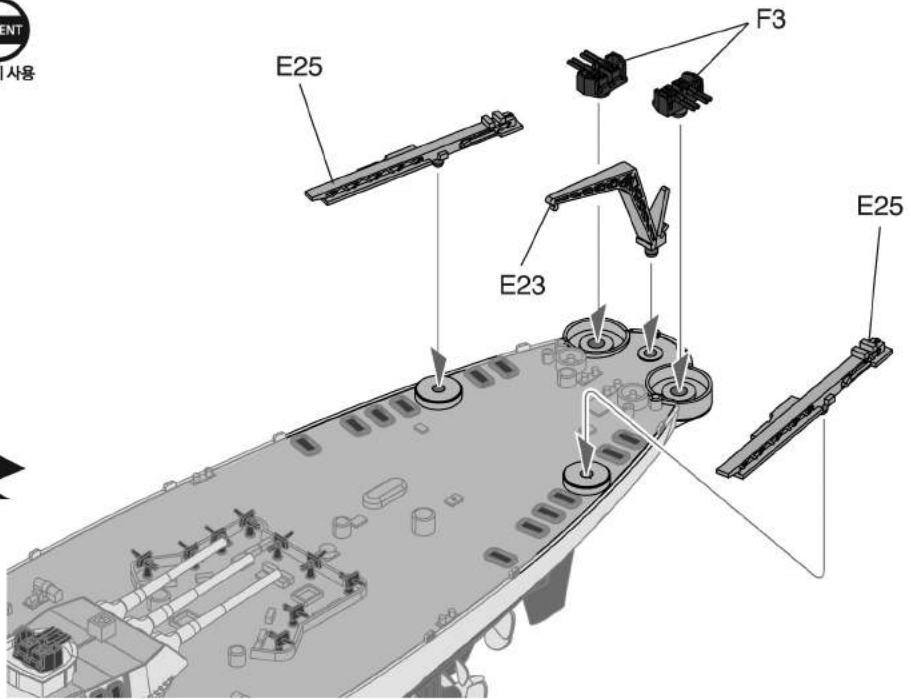

10



점착제 사용



Curtiss-SC-1
커티스-SC-1

X2
수만큼 조립

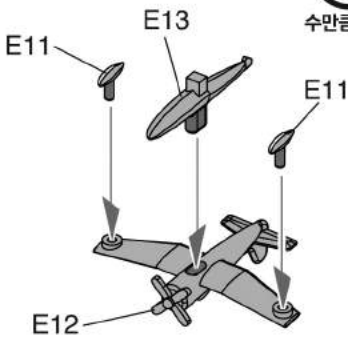

Front
앞방향

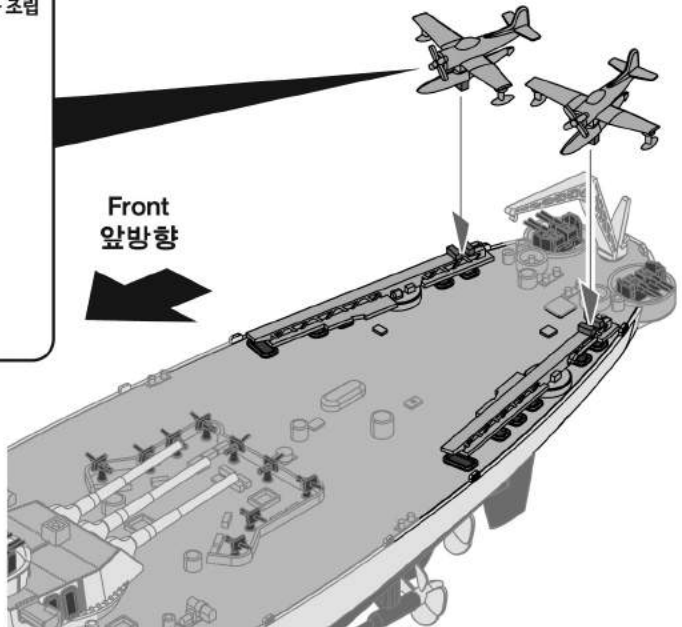

MANUAL 1



MANUAL 2

※ To be continued manual second time!
두번째 설명서로 이어집니다!

ACADEMY
HOBBY MODEL KITS

ACADEMY
ACADEMY PLASTIC MODEL CO., LTD.
고객상담번호: 02-910-8555

11



점착제 사용

Bridge part 2
함교부품 2

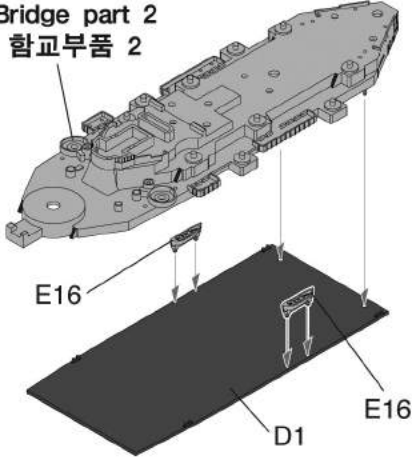

F4-8ea
F4-8개

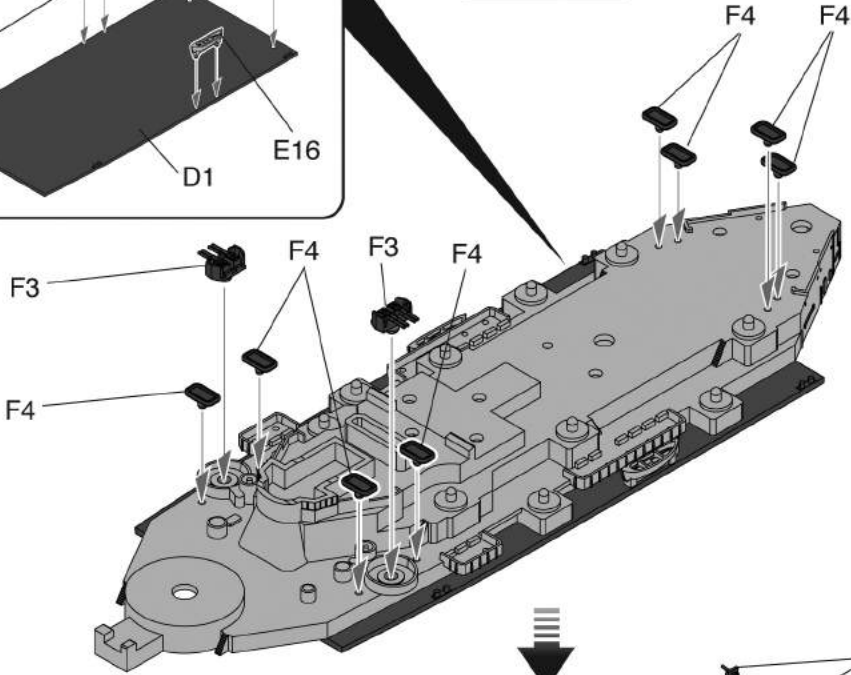

12



점착제 사용

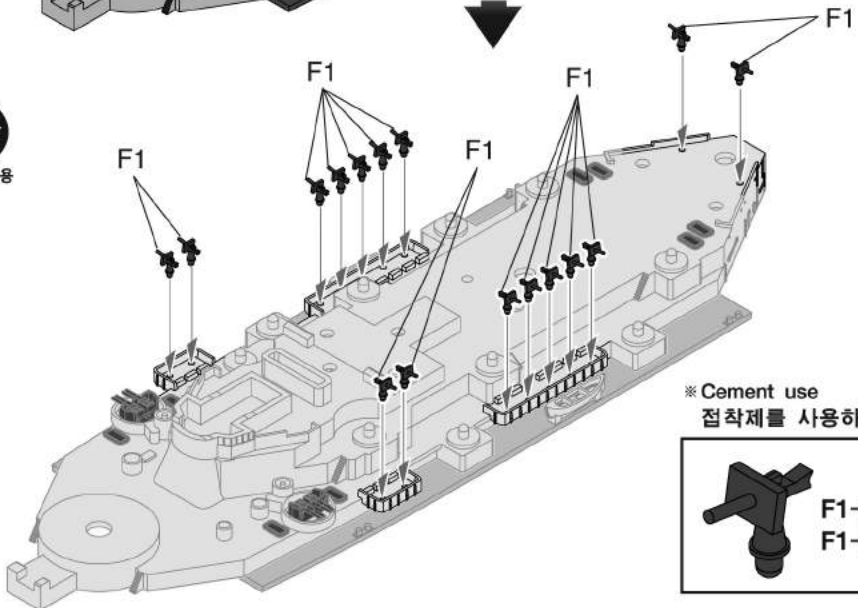

* Cement use
점착제를 사용하세요.



F1-16ea
F1-16개

13



점착제 사용

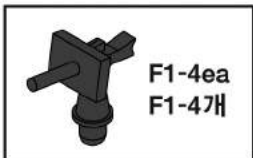
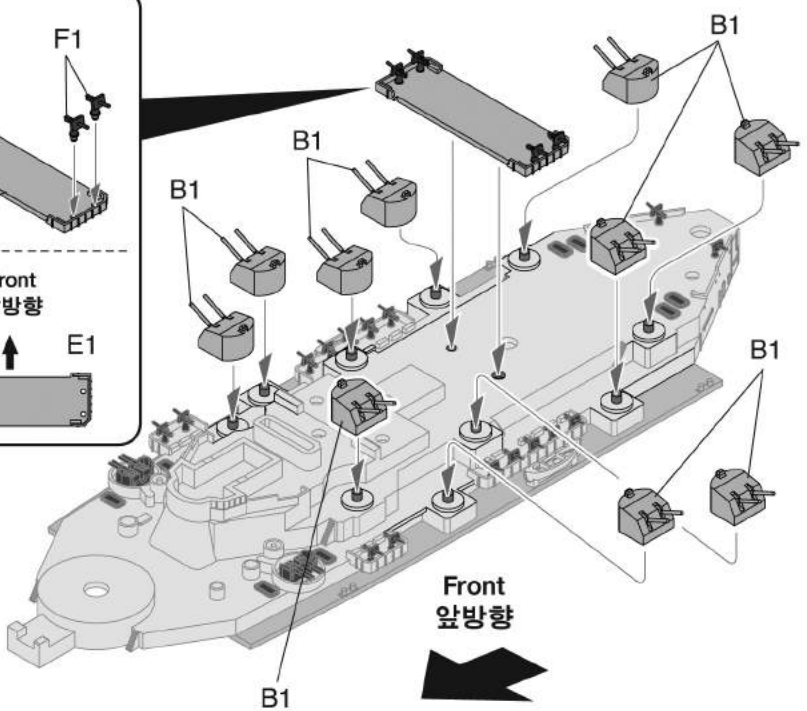
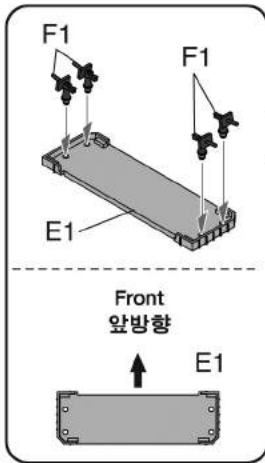

F1-4ea
F1-4개

14



점착제 사용

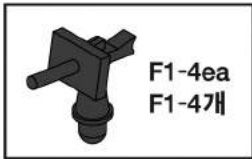
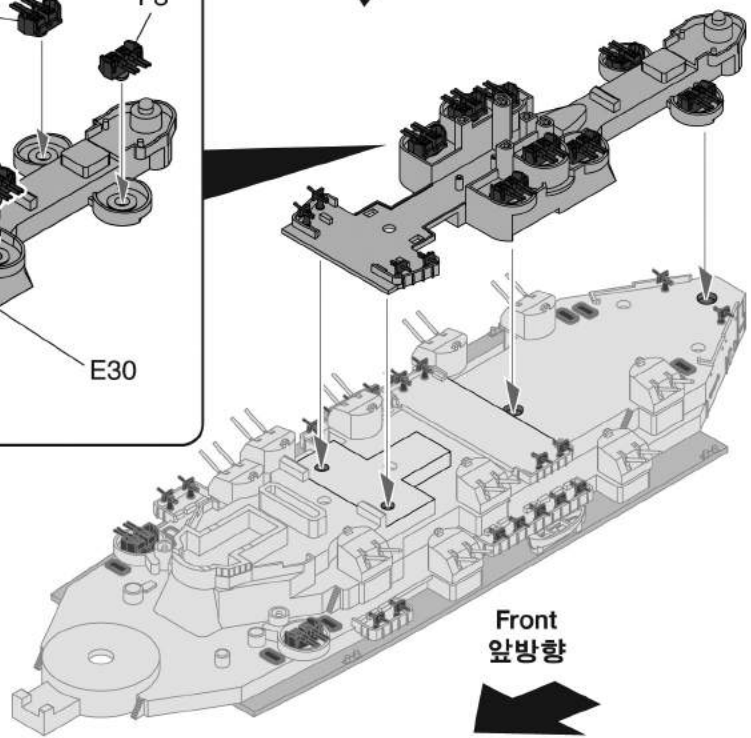
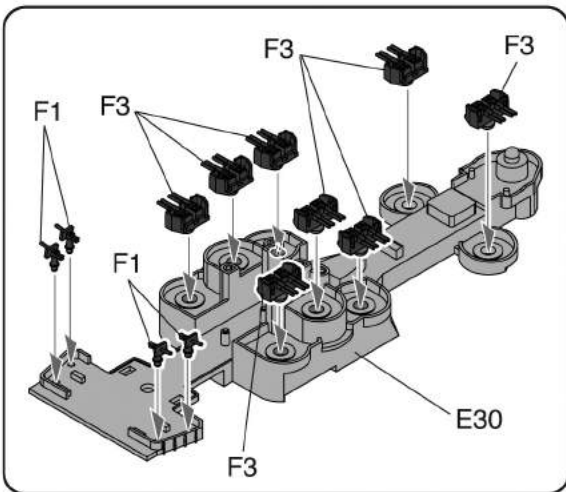

F1-4ea
F1-4개

15

접착제 사용

※ Start assemble with number ①

①번부터 조립 합니다.

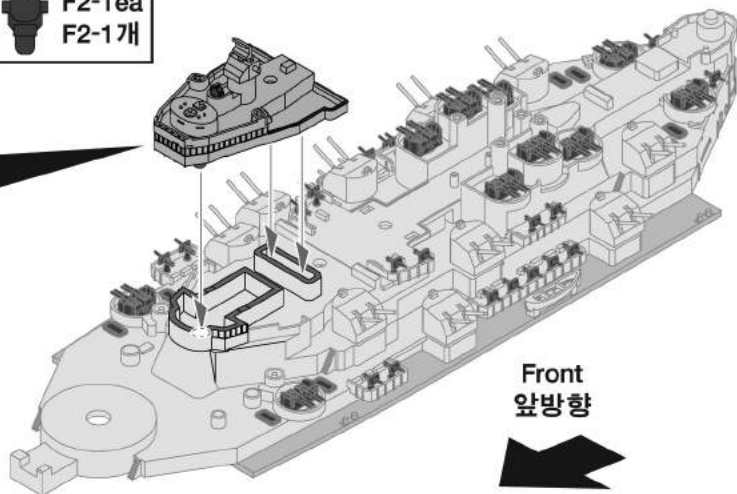
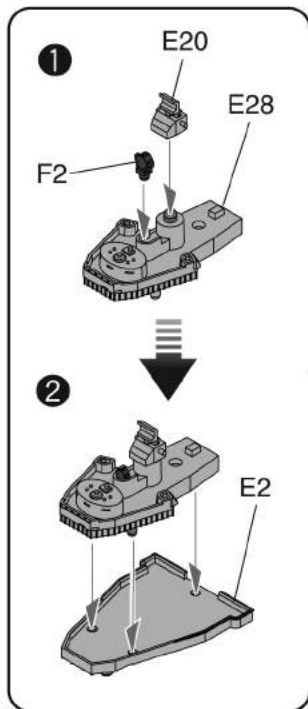
**16**

접착제 사용

※ Start assemble with number ①

①번부터 조립 합니다.

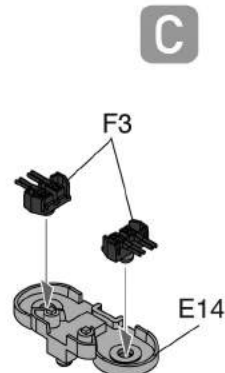
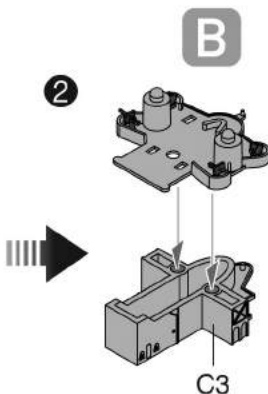
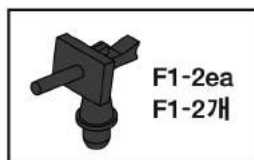
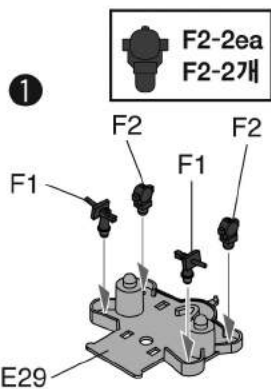
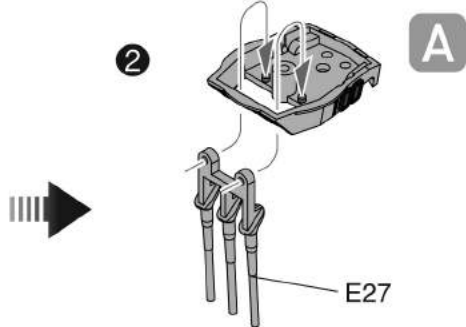
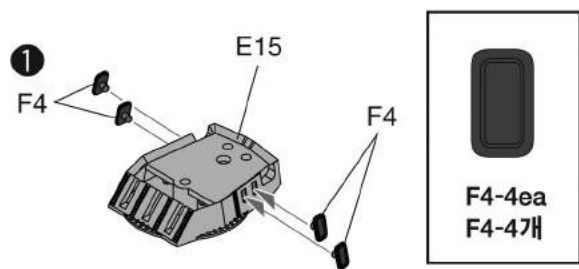

17



점착제 사용

※ First of all assemble.
가장 먼저 조립

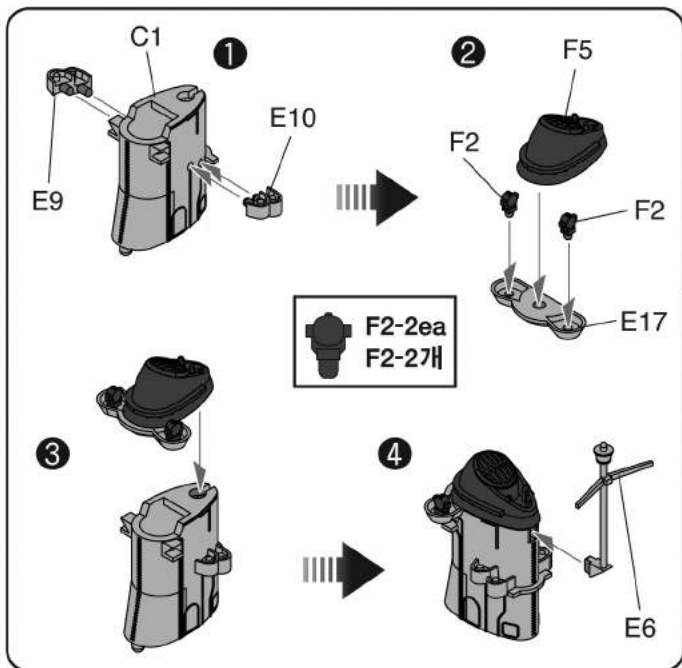
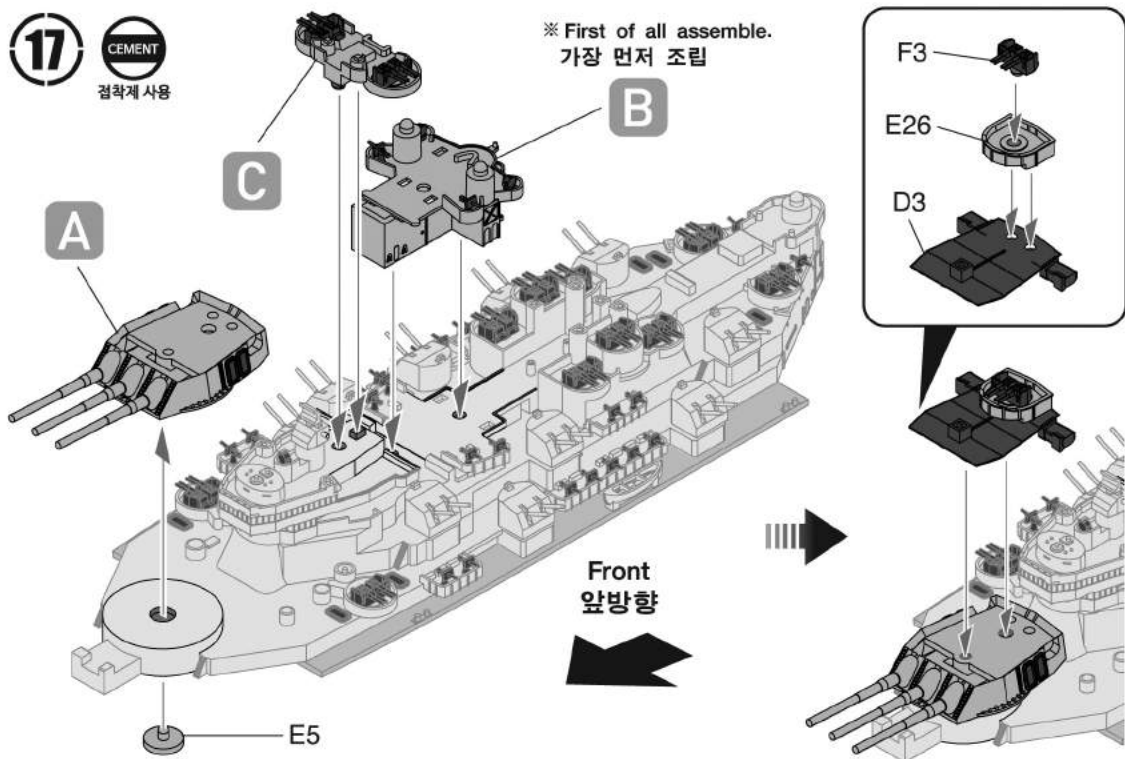

※ Start assemble with number 1
1번부터 조립 합니다.

18



점착제 사용

Front
앞방향



19



점착제 사용

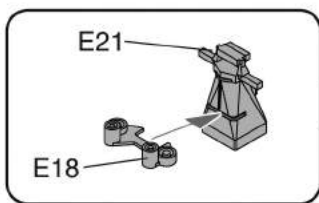

Front
앞방향

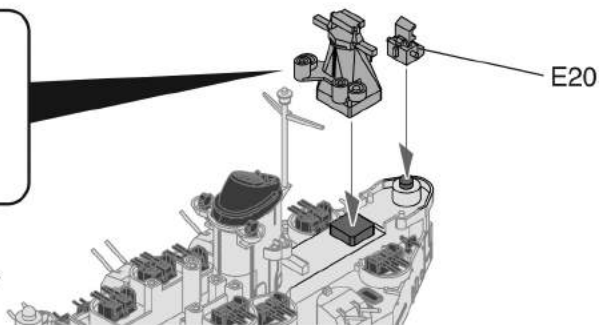

※ Start assemble with number ①

①번부터 조립 합니다.

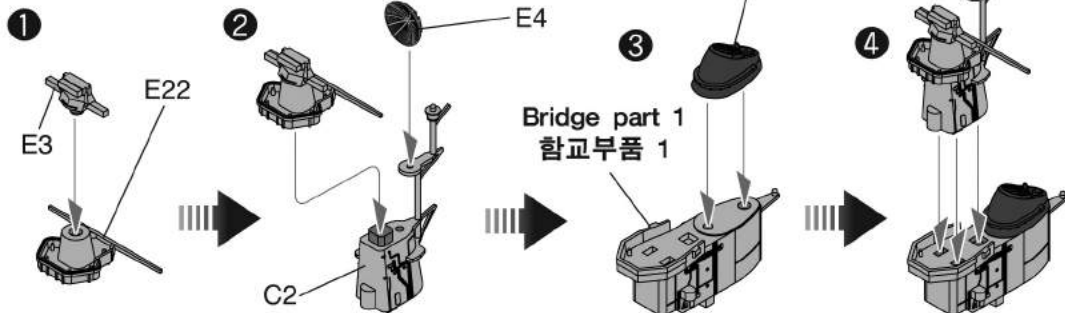

Top view
윗면

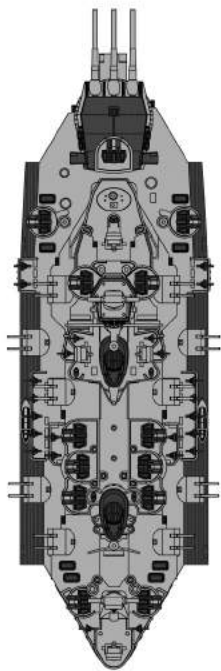

20



점착제 사용

Front
앞방향

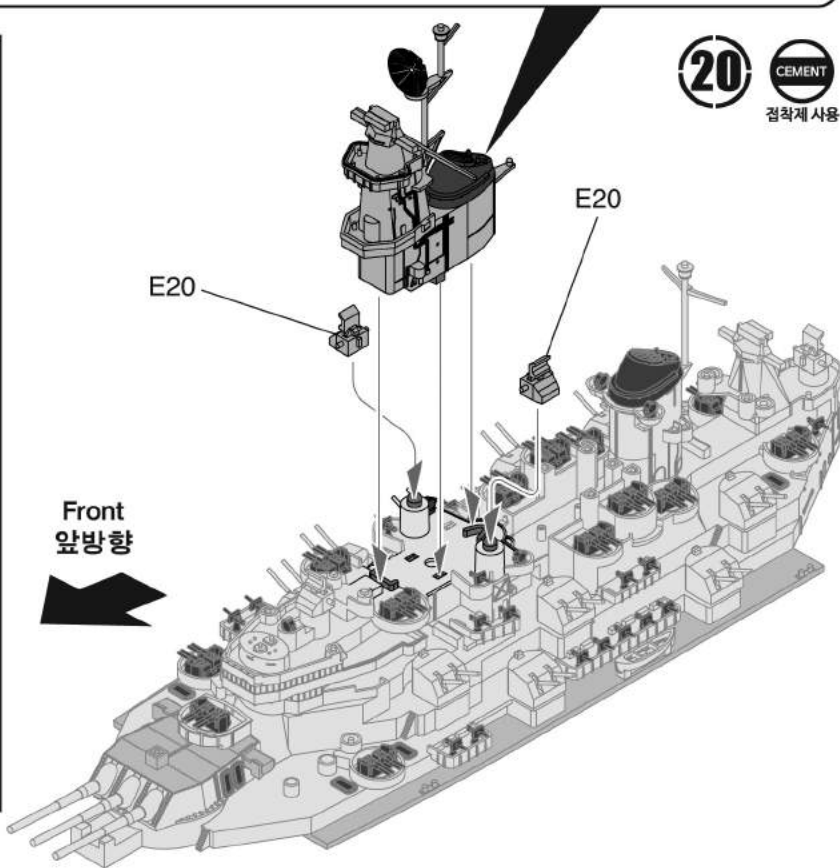

21



점착제 사용

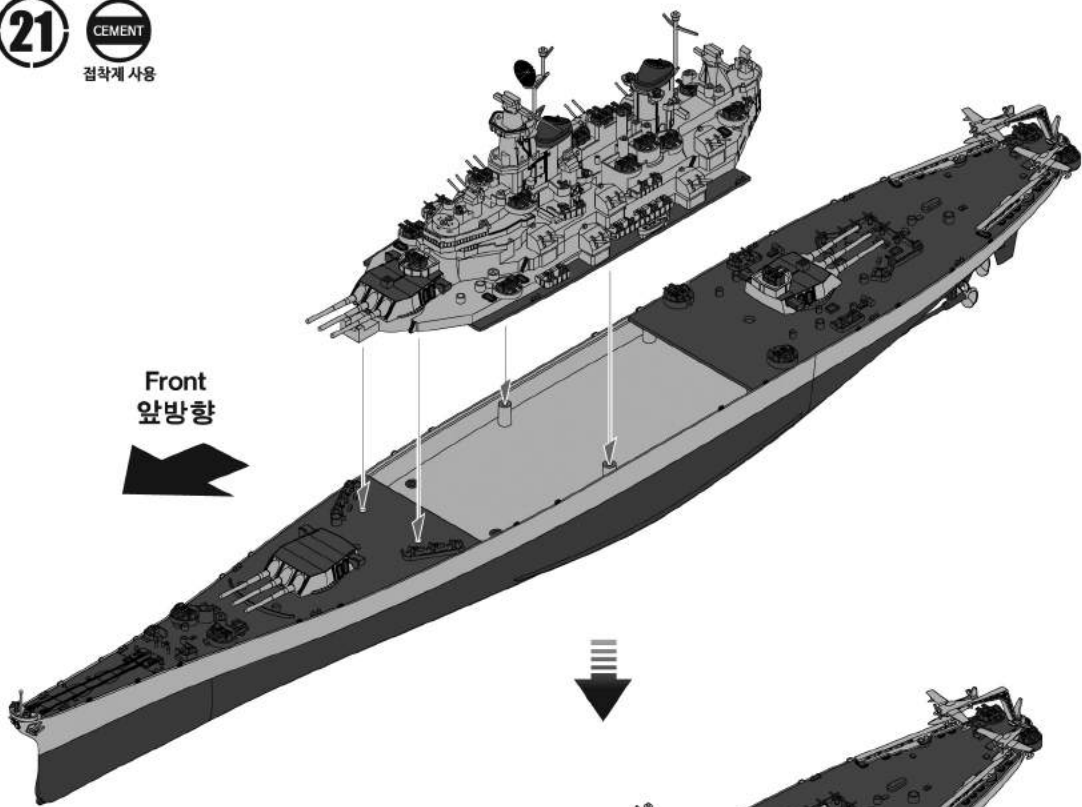

22



점착제 사용

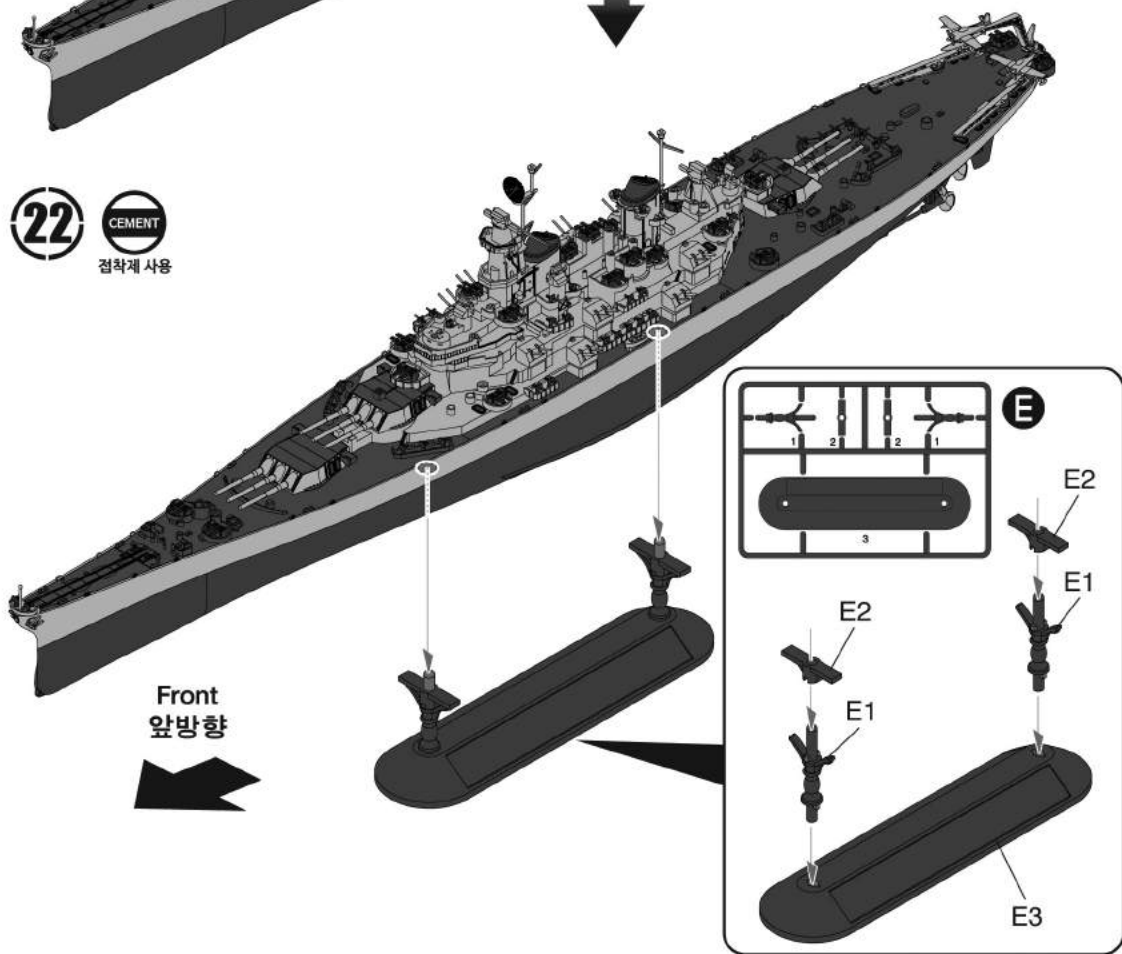

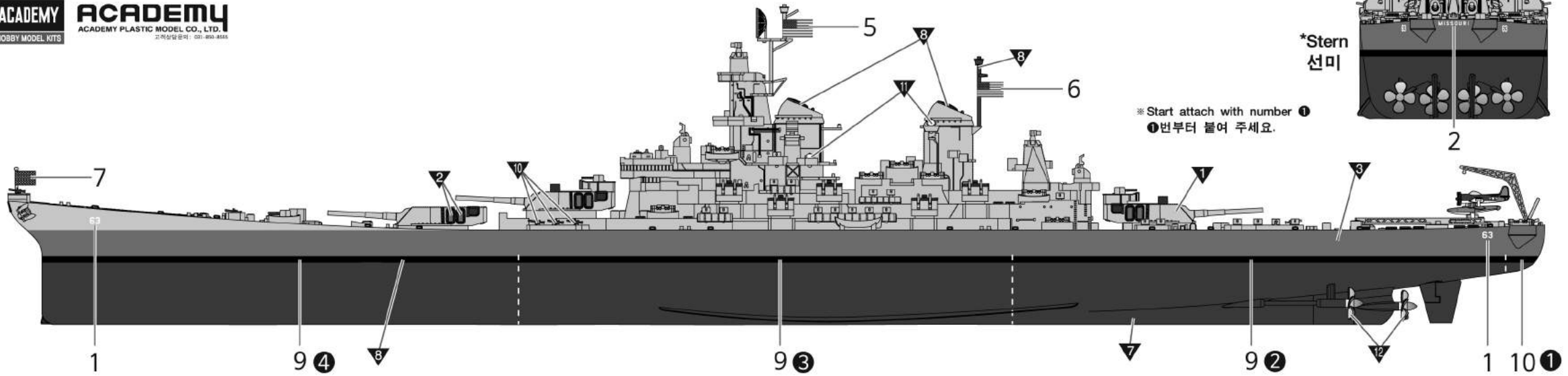

*Stern 선미

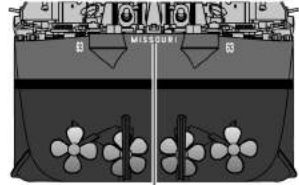

* Start attach with number 1
①번부터 붙여 주세요.

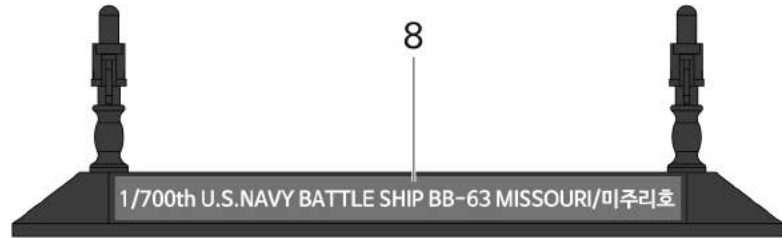
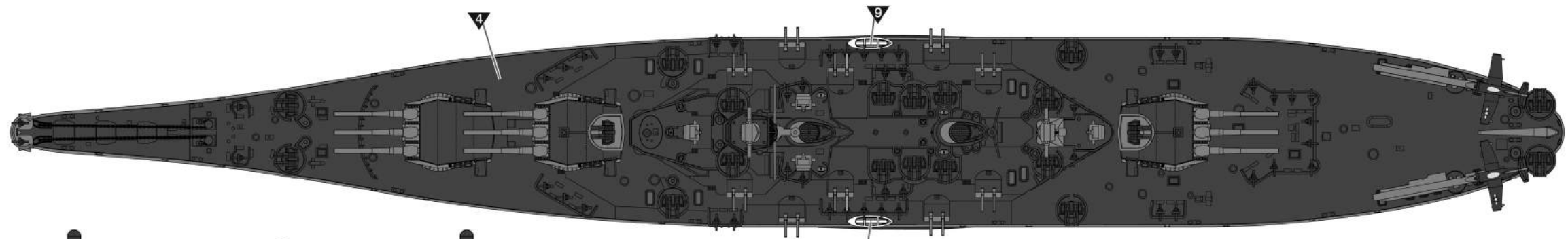

* () is opposite number.
()는 반대측 번호입니다.

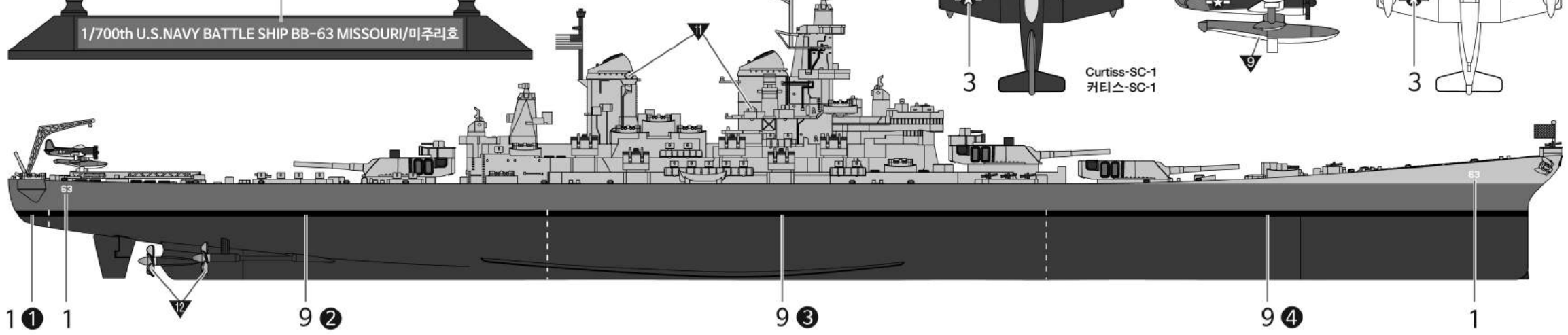
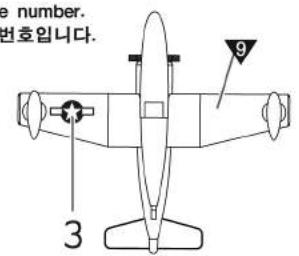
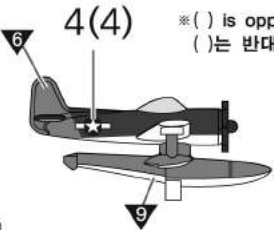
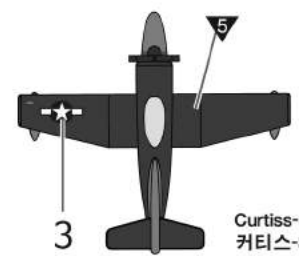



● Hull part 1
선체 부품 1



● Hull part 2
선체 부품 2



● Hull part 3
선체 부품 3



● Bridge part 1
함교부품 1



● Bridge part 2
함교부품 2

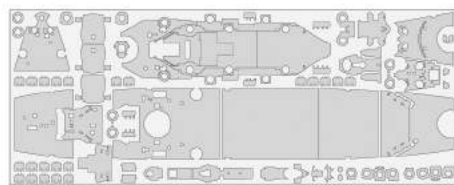

● Mask
마스킹 테이프

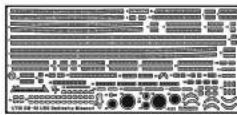

● Photo Etched
에칭

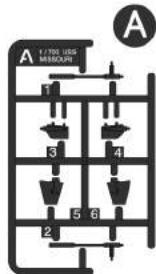

A

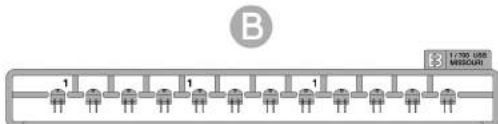

B

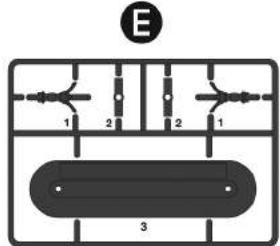

E

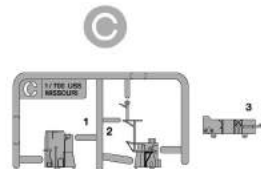

C

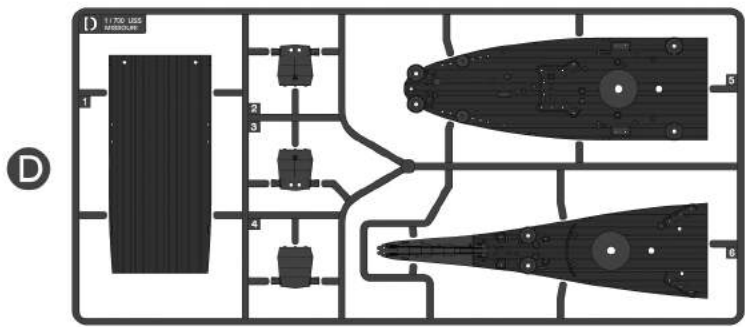

D

E

F X2

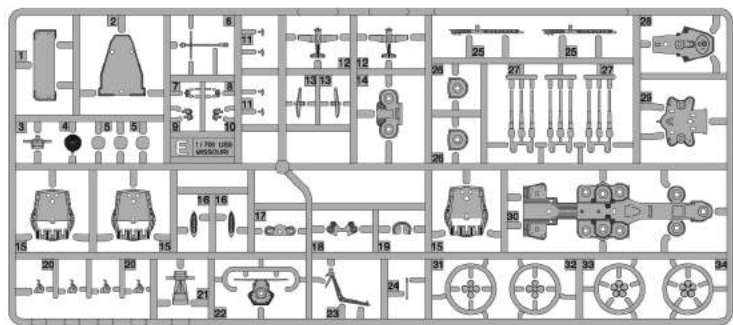

● Decal/ 전사지

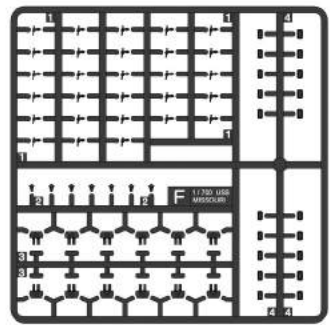

ACADEMY
HOBBY MODEL KITS

ACADEMY
ACADEMY PLASTIC MODEL CO., LTD.
교육산업단지 01-400-8955

